

# FURRION

## 50" 4K LED TV

*User Manual*

Model: FDUS50F1A



\* Product picture is for reference only.

# Welcome

Thank you for purchasing this Furrion 4K LED TV. Before operating your new product, please read these instructions carefully. This user manual contains information for safe use, installation and maintenance of the product.

The manufacturer does not accept responsibility for any damages due to not observing these instructions.

If you have any further questions regarding our products, please contact us at **support@furrion.com**

## **Supplier's Declaration of Conformity**

### **47 CFR § 2.1077 Compliance Information**

#### **Unique Identifier**

Trade Name: Furrion

Model No.: FDUS50F1A

#### **Responsible Party – U.S. Contact Information**

Furrion Innovation Center & Institute of Technology

52567 Independence Ct., Elkhart, IN 46514, USA

Toll free: 1-800-789-3341; Email: support@furrion.com

#### **FCC Compliance Statement**

This device complies with Part 15 of the FCC Rules. Operation is subject to the following two conditions: (1) This device may not cause harmful interference, and (2) this device must accept any interference received, including interference that may cause undesired operation.

# Table Of Contents

<b>Welcome</b> .....	<b>2</b>
<b>Contents</b> .....	<b>3</b>
<b>Safety Warnings</b> .....	<b>4</b>
Important Safety Instructions.....	4
Safety Precautions.....	7
<b>Function Overview</b> .....	<b>9</b>
Control Panel .....	9
Rear Panel.....	10
Unimote.....	11
<b>About Your 4K LED TV</b> .....	<b>13</b>
Features .....	13
Power Source .....	13
<b>Before Operation</b> .....	<b>14</b>
What's in the Box.....	14
Prepare your Remote Control.....	14
<b>Getting Started</b> .....	<b>15</b>
<b>TV Settings</b> .....	<b>16</b>
Setup Setting .....	16
Picture Setting.....	19
Audio Setting.....	20
Time Setting .....	21
Lock Setting .....	22
<b>TV Settings</b> .....	<b>25</b>
Channel Setting .....	25
<b>Change Settings</b> .....	<b>26</b>
USB Mode .....	26
<b>Troubleshooting</b> .....	<b>27</b>
<b>Specifications</b> .....	<b>28</b>

# Safety Warnings



**CAUTION**  
RISK OF ELECTRIC SHOCK  
DO NOT OPEN



**CAUTION:** TO REDUCE THE RISK OF ELECTRIC SHOCK, DO NOT REMOVE COVER (OR BACK). NO USER-SERVICEABLE PARTS INSIDE. REFER SERVICING TO QUALIFIED SERVICE PERSONNEL.



This 'bolt of lightning' indicates uninsulated material within your unit which may cause an electric shock. For the safety of everyone in your household, please do not remove product covering.



The 'exclamation mark' calls attention to features within the enclosed literature to prevent operating and maintenance problems.



This equipment is a Class II or double insulated electrical appliance. It has been designed in such a way that it does not require a safety connection to electrical earth.

**WARNING:** To reduce the risk of fire or electric shock, this apparatus should not be exposed to rain, moisture placed in the vicinity or objects filled with liquids (such as vases).

**CAUTION:** To prevent electric shock, fully insert the plug. For regions with polarized plugs: Please match wide blade to wide slot.

## Important Safety Instructions

1. Read these instructions.
2. Keep these instructions.
3. Heed all warnings.
4. Follow all instructions.
5. Do not use this apparatus near water.
6. Clean only with a dry cloth.
7. Do not block any of the ventilation openings. Install in accordance with the manufacturers instructions.
8. Do not install near any heat sources such as radiators, heat registers, stoves or other apparatus (including amplifiers) that produce heat.
9. Do not defeat the safety purpose of the polarized or grounding-type plug. A polarized plug has two blades with one wider than the other. A grounding type plug has two blades and a third grounding prong. The wide blade or the third prong are provided for your safety. When the provided plug does not fit into your outlet, consult an electrician for replacement of the obsolete outlet.
10. Protect the power cord from being walked on or pinched, particularly at plugs, convenience receptacles and the point where they exit from the apparatus.
11. Only use attachments/accessories specified by the manufacturer.
12. Use only with a cart, stand, tripod, bracket or table specified by the manufacturer or sold with the apparatus. When a cart is used, use caution when moving the cart/apparatus to avoid injury from tip-over.
13. Unplug this apparatus during lightning storms or when unused for long periods of time.
14. Refer all servicing to qualified service personnel. Servicing is required when the apparatus has been damaged in any way, such as if the power-supply cord or plug is damaged, liquid has been spilled or objects have fallen into the apparatus, or when the apparatus has been exposed to rain or moisture, does not operate normally, or has been dropped.
15. Apparatus should not be exposed to dripping or splashing, and objects filled with liquids, such as vases, should not be placed on the apparatus.



# Safety Warnings

16. An outside antenna system should not be located in the vicinity of overhead power lines or other electric light or power circuits, or where it can fall into such power lines or circuits. When installing an outside antenna system, extreme care should be taken to eliminate touching power lines or circuits as contact might be fatal.
17. Do not overload wall outlets, extension cords, or integral convenience receptacles as this can result in a risk of fire or electric shock.
18. Never push objects of any kind into this product through openings as they may touch short-out parts or dangerous voltage points that could result in a fire or electric shock. Never spill liquid of any kind on the product.
19. If an outside antenna is connected to the television equipment, be sure the antenna system is grounded so as to provide some protection against voltage surges and built up static charges. Section 810 of the National Electrical Code provides information with respect to proper grounding of the mast and supporting structure, grounding of the lead-in wire to an antenna discharge unit, size of grounding conductors, location of antenna discharge unit, connection to grounding electrodes, and requirements for the grounding electrodes.

20. NOTE TO CABLE/TV INSTALLER: This reminder is provided to call the CATV system installer's attention to Article 820-40 of the National Electric Code (U.S.A.). The code provides guidelines for proper grounding and, in particular, specifies that the cable ground shall be connected to the grounding system of the building, as close to the point of the cable entry as practical.
21. When replacement parts are required, be sure the service technician uses replacement parts specified by the manufacturer or those that have the same characteristics as the original part. Unauthorized substitutions may result in fire, electric shock or other hazards.
22. Upon completion of any service or repairs to this unit, ask the service technician to perform safety checks to determine that the unit is in proper operating condition.
23. When you connect the product to other equipment, turn off the power and unplug from the wall outlet. Failure to do so may cause an electric shock and serious personal injury. Read the owner's manual of the other equipment carefully and follow the instructions when making any connections.
24. Sudden high volume may cause hearing or speaker damage. When you use headphones (if the unit is equipped with a headphone jack), keep the volume at a moderate level. If you use headphones continuously with high volume, you may suffer hearing damage.
25. Do not allow the product to output distorted sound for extended periods of time. This may cause speaker overheating and fire.
26. The socket-outlet must be installed near the unit and easily accessible.
27. The mains plug is used as the disconnect and shall remain readily operable.

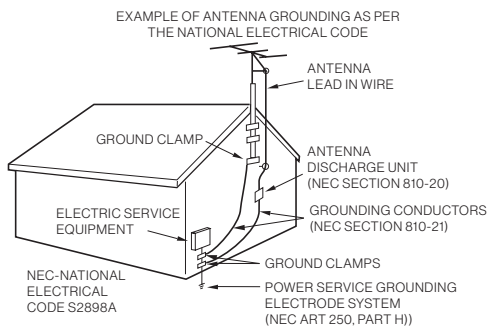

# Safety Warnings

28. Batteries (battery pack or batteries installed) shall not be exposed to excessive heat such as sunshine, fire or the like.

## CONDENSATION

Moisture will form in the operating section of the unit if the unit is brought from cool surroundings into a warm room or if the temperature of the room rises suddenly. When this happens the unit's performance will be impaired. To prevent this, let the unit stand in its new surroundings for about an hour before switching on, or make sure the room temperature rises gradually.

Condensation may also form during the summer if the unit is exposed to the breeze from an air conditioner. In such cases, change the location of the unit.

## HOW TO HANDLE THE LED PANEL

- Do not press hard or jolt the LED panel. It may cause the LED panel glass to break and injury may occur.
- If the LED panel is broken, make absolutely sure you do not touch the liquid in the panel. This may cause skin inflammation.
- If the liquid gets in your mouth, immediately gargle and consult with your doctor. Also, if the liquid gets in your eyes or touches your skin, consult your doctor after rinsing for at least 15 minutes in clean water.

Possible Adverse Effects on LED Panel: If a fixed (non-moving) pattern remains on the LED panel for long periods of time, the image can become permanently engrained and cause subtle but permanent ghost images. This type of damage is NOT COVERED BY YOUR WARRANTY. Never leave your LED panel on for long periods of time while it is displaying the following formats or images:

- Fixed images, such as stock tickers, video game patterns, TV station logos and websites.
- Special formats that do not use the entire screen. For example, viewing letterbox style (16:9) media on a normal (4:3) display (black bars at top and bottom of screen); or viewing normal style (4:3) media on a wide screen (16:9) display (black bars on left and right sides of screen).

The following symptoms are not signs of malfunction but technical limitation. Therefore we disclaim any responsibility for these symptoms.

- LED panels are manufactured using an extremely high level of precision technology, however sometimes parts of the screen may be missing picture elements or have luminous spots. This is not a sign of a malfunction.
- Do not install the LED panel near electronic equipment that produces electromagnetic waves. Some equipment placed too near this unit may cause interference.
- Effect on infrared devices – there may be interference while using infrared devices such as infrared cordless headphones.

**Power source:** This LED TV is designed to operate on 100~240 volt 50/60 Hz, AC current. Insert the power cord into a 100~240 volt 50/60 Hz outlet.

To prevent electric shock, do not use the LED TV's (polarized) plug with an extension cord, receptacle, or other outlet unless the blades and ground terminal can be fully inserted to prevent blade exposure.

**Warning:** To reduce the risk of fire or electric shock, do not expose this apparatus to rain or moisture.

# Safety Warnings

**Caution:** Never remove the back cover of the LED TV as this can expose you to very high voltages and other hazards. If the TV does not operate properly, unplug the LED TV and call your authorized dealer or service center.

Adjust only those controls that are covered in the instructions, as improper changes or modifications not expressly approved by Furrion could void the user's warranty.

## COMPLIANCE

### FCC Statement

**Note:** This equipment has been tested and found to comply with the limits for a Class B digital device, pursuant to Part 15 of the FCC Rules. These limits are designed to provide reasonable protection against harmful interference in a residential installation. This equipment generates, uses and can radiate radio frequency energy and, if not installed and used in accordance with the instructions, may cause harmful interference to radio communications.

However, there is no guarantee that interference will not occur in a particular installation. If this equipment does cause harmful interference to radio or television reception, which can be determined by turning the equipment off and on, the user is encouraged to try to correct the interference by one or more of the following measures:

- Reorient or relocate the receiving antenna.
- Increase the separation between the equipment and receiver.
- Connect the equipment into an outlet on a circuit different from that to which the receiver is connected.
- Consult the dealer or an experienced radio/TV technician for help.

**WARNING:** Changes or modifications to this unit not expressly approved by the party responsible for compliance could void the user's authority to operate this equipment under FCC Rules.

This device complies with part 15 of the FCC Rules. Operation is subject to the following two conditions:

1. This device may not cause harmful interference.
2. This device must accept any interference received, including interference that may cause undesired operation.

## Safety Precautions

**WARNING:** Never place a television set in an unstable location. A television set may fall, causing serious personal injury or death. Many injuries, particularly to children, can be avoided by taking simple precautions such as:

- Using cabinets or stands recommended by the manufacturer of the television set.
- Only using furniture that can safely support the television set.
- Ensuring the television set is not overhanging the edge of the supporting furniture.
- Not placing the television set on tall furniture (for example, cupboards or bookcases) without anchoring both the furniture and the television set to a suitable support.
- Not placing the television set on cloth or other materials that may be located between the television set and supporting furniture.
- Educating children about the dangers of climbing on furniture to reach the television set or its controls.

# Safety Warnings

If your existing television set is being retained and relocated, the same considerations as above should be applied.

The unit emits heat when in operation. Do not place any covers or blankets on the unit, this may cause overheating. Do not block ventilation holes, or set up near radiators. Do not place in direct sunlight. When placing on a shelf, leave 4 inches (10 cm) free space around the entire unit.

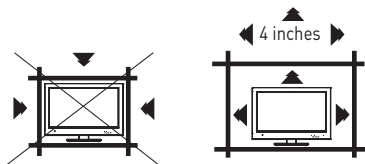

## Notes when mounting the LED TV on the wall

If the unit is to be mounted on the wall, contact the retailer where you purchased the LED TV for advice, and have the equipment professionally installed. Incomplete or improper installation may cause injury to you and/or damage to the LED TV.

### **WARNING:**

- Do not use this TV with wall mounts that allow the TV to tilt vertically. Vertical tilting wall mounts may cause structural damage to the TV.
- Use **ONLY** fixed or horizontal swiveling wall mounts with this TV.

## **Notice for TV Cabinet**

If the unit is to be mounted on a cabinet smaller than the length of the unit, it could result in an unstable location. The unit may tumble over, making a risk of personal, possibly fatal injury. This would also damage the product seriously. Accordingly, Furrion accepts no responsibility or liability for any injuries or property damage resulting from the improper installation.

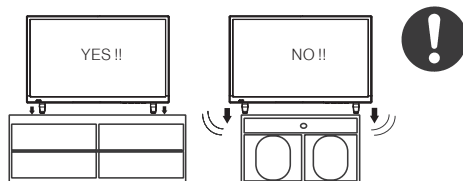



# Function Overview

## Control Panel

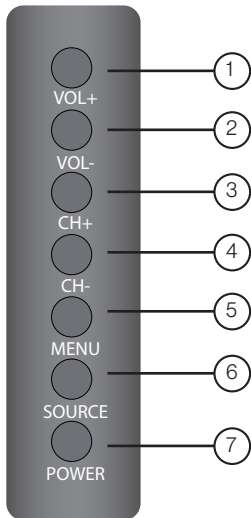

Item	Button	Function
①	<b>VOL+</b>	Press to increase volume
②	<b>VOL-</b>	Press to decrease volume
③	<b>CH+</b>	Press to skip to the next channel
④	<b>CH-</b>	Press to skip to the previous channel
⑤	<b>MENU</b>	Press to enter the main menu
⑥	<b>SOURCE</b>	Press to select the input source
⑦	<b>POWER</b>	Press to switch the TV on/off

\* Please note that the button layout of the controls may vary from model to model.

# Function Overview

## Rear Panel

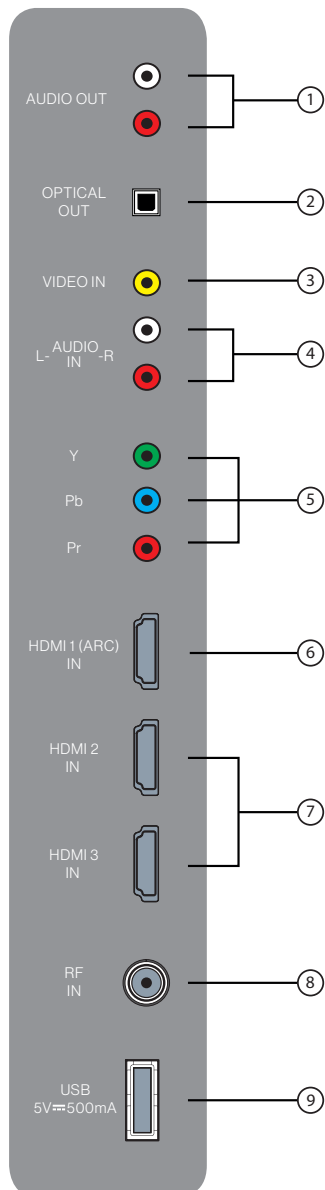

Item	Port	Function
①	<b>AUDIO OUT</b>	Connects to the AUDIO IN ports of an audio device
②	<b>OPTICAL OUT</b>	Connects to the OPTICAL AUDIO IN port of an audio device.
③	<b>VIDEO IN</b>	Connects to the VIDEO OUT ports of an audio device.
④	<b>L-AUDIO IN-R</b>	Connects to the AUDIO OUT ports of an audio device.
⑤	<b>Y</b> <b>P<sub>b</sub></b> <b>P<sub>r</sub></b>	Connects to the COMPONENT VIDEO OUT ports of a DVD Player, Cable Box or other compatible device.
⑥	<b>HDMI 1 (ARC)</b>	Connects to the HDMI OUT port of a DVD Player, Games Console, Cable Box or other HDMI device. ARC Audio Return Channel When connected with a HDMI 1.4 cable to an ARC compatible audio system, the TV links with the device to give extra audio functionality.
⑦	<b>HDMI 2</b> <b>HDMI 3</b>	Connects to the HDMI OUT port of a DVD Player, Games Console, Cable, Box or other HDMI device. <u>CEC (Consumer Electronics Control)</u> When connected to the CEC compatible Furrion Entertainment Systems or other CEC Compatible devices, the TV links with the system to give extra functionality.
⑧	<b>RF IN</b>	Connects to the ANTENNA, CABLE, or CABLE BOX
⑨	<b>USB</b>	USB Port: view pictures and listen to MP3s via a compatible USB stick

\* The configuration of the connection ports may vary from model to model.

# Function Overview

## Unimote

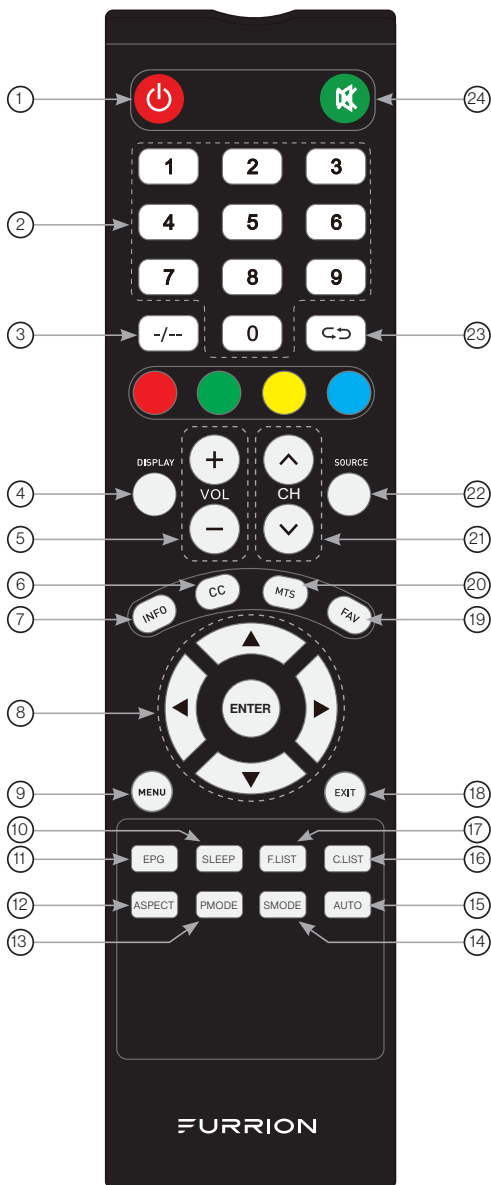

Item	Button	Function
①		Turn on/off the TV/Entertainment System.
②	<b>NUMBER BUTTONS</b>	Enters numbers or select channels.
③	<b>-/--</b>	Toggles between single & double digit input.
④	<b>DISPLAY</b>	Display the information.
⑤	<b>VOL+/-</b>	Increases/decreases volume.
⑥	<b>CC</b>	Closed Captions On & Off.
⑦	<b>INFO</b>	In TV mode, press to display information on the selected TV channel; In Stereo mode, press to display DVD playback status.
⑧	<b>NAVIGATION &amp; ENTER BUTTONS</b>	Navigates within a menu and press ENTER to confirm your selection.
⑨	<b>MENU</b>	Enters the main menu.
⑩	<b>SLEEP</b>	Sets the sleep timer.
⑪	<b>EPG</b>	Displays the program guide.
⑫	<b>ASPECT</b>	Cycles through available display aspect ratios.
⑬	<b>P.MODE</b>	Cycles through picture modes.
⑭	<b>S.MODE</b>	Cycles through sound modes.
⑮	<b>AUTO</b>	Cycles through MTS sound modes.
⑯	<b>C.LIST</b>	Displays the channel list.
⑰	<b>F.LIST</b>	Displays the favorites list.
⑱	<b>EXIT</b>	Exits the current menu.
⑲	<b>FAV</b>	Adds or deletes the current channel from the favorites channel list.
⑳	<b>MTS</b>	Cycles through MTS sound modes.
㉑	<b>CH+/-</b>	Channel Up/Down.
㉒	<b>SOURCE</b>	Cycles through input sources.
㉓		Toggles between the current and previous channel.
㉔		Toggles audio On or Off.

# About Your 4K LED TV

## Features

---

**Closed Caption Decoder With Full Text Mode** - Displays text captions or full screen text on the screen for hearing impaired viewers.

**Picture Adjustments Using The Remote Control** - The On-Screen display allows precise remote control adjustment of BRIGHTNESS, CONTRAST, COLOR, TINT and SHARPNESS.

**Programmable TV Sleep Timer** - Operable from the remote control, the TV can be programmed for up to 240 minutes to turn off automatically.

**On-Screen 3 Language Display** - You can select one of 3 languages, English, Spanish or French for on-screen programming.

**HDMI/Component Video Jacks** - A VCR, DVD player, satellite receiver or other audio/video component can be connected to this unit.

## Power Source

---

### NOTE:

- Please make sure to insert the cord securely at both the LED TV and the wall outlet.

### WARNING:

- DO NOT CONNECT THIS UNIT TO THE POWER USING ANY DEVICE OTHER THAN THE SUPPLIED AC CORD. THIS COULD CAUSE FIRE, ELECTRICAL SHOCK, OR DAMAGE.
- DO NOT USE WITH A VOLTAGE OTHER THAN THE POWER VOLTAGE SPECIFIED. THIS COULD CAUSE FIRE, ELECTRICAL SHOCK, OR DAMAGE.

### CAUTION:

- WHEN THIS UNIT IS NOT USED FOR A LONG TIME (E.G., AWAY ON A TRIP), IN THE INTEREST OF SAFETY, BE SURE TO UNPLUG IT FROM THE AC OUTLET.
- DO NOT PLUG/UNPLUG THE AC CORD WHEN YOUR HANDS ARE WET. THIS MAY CAUSE ELECTRICAL SHOCK.
- IF YOU NEED TO REPLACE THE SUPPLIED AC ADAPTER OR AC CORD, THE SPECIFIED ONE IS RECOMMENDED. CONTACT THE DEALER THAT YOU PURCHASED THE UNIT FROM.

# Before Operation

## What's in the Box

---

Thanks for purchasing this Furrion 4K LED TV. First, check the contents of your box with the parts checklist below:

- TV
- Remote control
- AAA battery × 2
- Wall-mount screws × 4 (PM6X12mm)
- Bottom mount stand × 2
- Bottom mount stand screws × 4
- Quick Start Guide
- Warranty Manual
- Warning card

## Prepare your Remote Control

---

### BATTERY INSTALLATION

1. Open battery compartment cover.

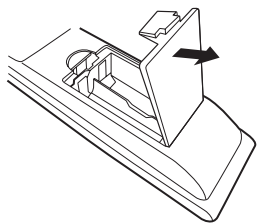

2. Install two AAA batteries.

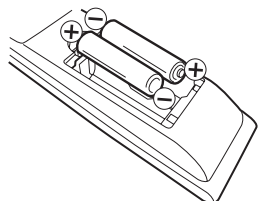

3. Close the cover of the battery compartment.

**NOTE:** Use two “AAA” size batteries. The batteries may last approximately one year depending on how much the remote control is used. For best performance, it is recommended that batteries should be replaced on a yearly basis, or when the remote operation becomes erratic. Do not mix old and new batteries or different types.

### BATTERY PRECAUTIONS

These precautions should be followed when using batteries in this device:

- Use only the size and type of batteries specified.
- Be sure to follow the correct polarity when installing the batteries as indicated in the battery compartment. Reversed batteries may cause damage to the device.
- Do not mix different types of batteries together (e.g. Alkaline and Carbon-zinc) or old batteries with fresh ones.
- If the device is not to be used for a long period of time, remove the batteries to prevent damage or injury from possible battery leakage.
- Do not try to recharge batteries not intended to be recharged; they can overheat and rupture. (Follow battery manufacturer's directions.)
- Please use caution when inserting batteries to avoid battery damage. If the spring terminal in the remote control remains in contact with a side of a damaged battery it can cause a short circuit. Never use damaged batteries as they can become very hot and are dangerous.

# Getting Started

The **Setup Wizard** window appears the first time you turned on the TV. It will assist you to configure the TV and scan for available channels.

**IMPORTANT:** Make sure the antenna or cable TV system connection is made.

1. Press **POWER** button on the TV control panel or  button on the remote control to switch on the TV. The power indicator will change to green. The **Setup Wizard** window appears on the screen.

**NOTE:** It may take a few seconds before the Setup Wizard window appears on the screen.

2. Use **▲** or **▼** to select **Home Mode (Energy Saving)** or **Standard Mode**. Press **OK** to enter the next menu.



3. When you select **Home Mode**, Use **▲** or **▼** to select **Yes** or **No**. Press **OK** to enter the next menu or press **MENU** to return to the previous menu.

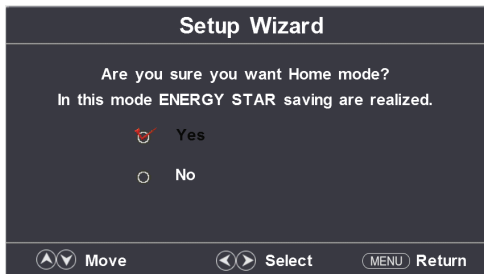

3. Use **▲** / **▼** / **◀** / **▶** to navigate and select your desired settings.



Setup Wizard	
<b>Menu Language</b>	Use <b>▲</b> or <b>▼</b> to highlight <b>Menu Language</b> , then press <b>◀</b> or <b>▶</b> to select English, French or Spanish.
<b>Air/Cable</b>	Use <b>▲</b> or <b>▼</b> to highlight <b>Air/Cable</b> , then press <b>◀</b> or <b>▶</b> to select Air or Cable.
<b>Cable System</b>	Use <b>▲</b> or <b>▼</b> to highlight <b>Cable System</b> , then press <b>◀</b> or <b>▶</b> to select Auto, STD, IRC or HRC. <b>NOTE:</b> Only adjustable when "Air/Cable" is set as "Cable" mode.
<b>Auto Scan</b>	Use <b>▲</b> or <b>▼</b> to highlight <b>Auto Scan</b> , then press <b>OK</b> or <b>▶</b> to start scanning all the channels available in your area.

**NOTE:** You may press **MENU** at any time to exit the menu.



\*The Setup Wizard will scan for available channels automatically. The scanning may take some time.

# TV Settings

## Setup Setting

1. Press **MENU** button to display the main menu.
2. Use ◀ or ▶ to highlight **Setup** mode.
3. Use ▲ or ▼ to highlight the item you would like to reset, then press ◀ or ▶ to select the settings.
4. Press **MENU** to return to the previous menu or exit the setting.



## Setup Menu

<b>Menu Language</b>	Select the menu language.	Press ◀ or ▶ to select <b>English, Français</b> or <b>Español</b> .
<b>Transparency</b>	Control the transparency level of the menu.	Press ◀ or ▶ to select <b>0% / 25% / 50% / 75% / 100%</b> .
<b>Zoom Mode</b>	Set the picture proportion.	Press ◀ or ▶ to select <b>Zoom, Normal, Cinema</b> or <b>Wide</b> .

# TV Settings

## Setup Menu

<b>Closed Caption</b>	Configure Closed Caption functions.	<b>CC Mode</b>	Press ◀ or ▶ to select <b>CC On, CC Off</b> or <b>CC On Mute</b> .
		<b>Analog CC</b>	Press ◀ or ▶ to select <b>CC1, CC2, CC3, CC4, Text 1, Text 2, Text 3</b> or <b>Text 4</b> .
		<b>Digital CC</b>	Press ◀ or ▶ to select <b>Off, Service1, Service 2, Service 3, Service 4, Service 5</b> or <b>Service 6</b> .
		<b>Mode</b>	Press ◀ or ▶ to select <b>Default</b> or <b>Custom</b> .
		<b>Font Style</b>	Press ◀ or ▶ to select <b>Default, Font 0, Font 1, Font 2, Font 3, Font 4, Font 5, Font 6</b> or <b>Font 7</b> .
		<b>Font Size</b>	Press ◀ or ▶ to select <b>Default, Normal, Large</b> or <b>Small</b> .
		<b>Font Edge Style</b>	Press ◀ or ▶ to select <b>Default, None, Raised, Depressed, Uniform, Left Shadow</b> or <b>Right Shadow</b> .
		<b>Font Edge Color</b>	Press ◀ or ▶ to select <b>Default, Black, White, Red, Green, Blue, Yellow, Magenta</b> or <b>Cyan</b> .
		<b>FG Color</b>	Press ◀ or ▶ to select <b>Default, White, Red, Green, Blue, Yellow, Magenta</b> or <b>Cyan</b> .
		<b>BG Color</b>	Press ◀ or ▶ to select <b>Default, Black, Red, Green, Blue, Yellow, Magenta</b> or <b>Cyan</b> .
		<b>Option</b> * Press <b>OK</b> or ▶ to enter the sub menu	
<b>Setup Wizard</b>	Start the Setup Wizard.	Press <b>OK</b> or ▶ to enter <b>Setup Wizard</b> .	



# TV Settings

## Setup Menu

<b>HDMI CEC</b>	Press <b>▶</b> to enter sub-menu, then press <b>◀</b> or <b>▶</b> to select <b>Off / On</b> for HDMI CEC. When selecting <b>On</b> , the sub-menu in the right column will be available to set up.	<b>Auto Standby</b>	Press <b>◀</b> or <b>▶</b> to select <b>Off</b> or <b>On</b> . *In <b>On</b> mode, TV will shut down when there is no signal for several minutes.
		<b>Auto TV on</b>	Press <b>◀</b> or <b>▶</b> to select <b>Off</b> or <b>On</b> . *In <b>On</b> mode, TV will automatically turn on when the connected CEC device is turned on.
		<b>HDMI ARC</b>	Press <b>◀</b> or <b>▶</b> to select <b>Off</b> or <b>On</b> . *Set the HDMI ARC <b>On</b> if you want to enable the ARC function with a connected 5.1/7.1 Home Theater System.
		<b>Device control</b>	Press <b>◀</b> or <b>▶</b> to select <b>Off</b> or <b>On</b> . * In <b>On</b> mode, it allows a connected CEC device to be controlled by TV remote control.
		<b>Device list</b>	Press <b>▶</b> to display a list of HDMI CEC devices currently connected to the TV.
<b>EDID Switch</b>	Select the EDID version.	Press <b>◀</b> or <b>▶</b> to select <b>Auto</b> , <b>EDID 1.4</b> or <b>EDID 2.0</b> .	
<b>Restore Default</b>	Reset to factory default settings.	Press <b>◀</b> or <b>▶</b> to select <b>Yes</b> or <b>No</b> .	
<b>NOTE:</b> HDMI CEC function is only available when connecting with a CEC device.			

# TV Settings

## Picture Setting

1. Press **MENU** button to display the main menu.
2. Use ◀ or ▶ to highlight **Picture** mode.
3. Use ▲ or ▼ to highlight the item you would like to reset, then press ◀ or ▶ to select the settings.
4. Press **MENU** to return to the previous menu or exit the setting.



### Picture Menu

<b>Picture Mode</b>	Select the display mode.	Press ◀ or ▶ to select <b>EnergySaving/User/Standard/Dynamic/Mild</b> . *The <b>Energy Saving</b> feature adjusts the brightness of the TV in order to save energy and reduce power consumption.
<b>Contrast</b>	Control the contrast level of the picture.	Press ◀ or ▶ to increase or decrease contrast intensity. * Only adjustable after set " <b>Picture Mode</b> " as " <b>User</b> " mode.
<b>Brightness</b>	Control the brightness level of the picture.	Press ◀ or ▶ to increase or decrease the overall brightness. * Only adjustable after set " <b>Picture Mode</b> " as " <b>User</b> " mode.
<b>Color</b>	Control the color level of the picture.	Press ◀ or ▶ to increase or decrease the color intensity. * Only adjustable after set " <b>Picture Mode</b> " as " <b>User</b> " mode.
<b>Tint</b>	Control picture tint.	Press ◀ or ▶ to adjust colors toward green or reddish tint. * Only available under NTSC signal.
<b>Sharpness</b>	Control the sharpness of the picture.	Press ◀ or ▶ to soften or enhance edges in the picture. * Only adjustable after set " <b>Picture Mode</b> " as " <b>User</b> " mode.
<b>Color Temp</b>	Select the color mode.	Press ◀ or ▶ to select <b>Medium / Warm / Cool</b> .
<b>HDR</b>	Select the level of HDR imaging.	Press ◀ or ▶ to select <b>Middle / Strong / Weak</b> .

# TV Settings

## Audio Setting

1. Press **MENU** button to display the main menu.
2. Use **◀** or **▶** to highlight **Audio** mode.
3. Use **▲** or **▼** to highlight the item you would like to reset, then press **◀** or **▶** to select the settings.
4. Press **MENU** to return to the previous menu or exit the setting.

**NOTE:** The display menu may vary while different input source was selected.



### Audio Menu

<b>Sound Mode</b>	Select the sound mode.	Press <b>◀</b> or <b>▶</b> to select <b>Standard, Music, Movie, Sport</b> or <b>User</b> mode.	
<b>Bass</b>	Control the bass level.	Press <b>◀</b> or <b>▶</b> to increase or decrease low frequency intensity.	
<b>Treble</b>	Control the treble level.	Press <b>◀</b> or <b>▶</b> to increase or decrease high frequency intensity.	
<b>Balance</b>	Control the balance level.	Press <b>◀</b> or <b>▶</b> to adjust the desired level between 0-100.	
<b>Surround</b>	Control the surround effect.	Press <b>◀</b> or <b>▶</b> to select <b>On</b> or <b>Off</b> .	
<b>AVC</b>	(Auto Volume Control) Control the maximum power output.	Press <b>◀</b> or <b>▶</b> to select <b>On</b> or <b>Off</b> .	
<b>SPDIF Type</b>	Select the SPDIF sound mode.	Press <b>◀</b> or <b>▶</b> to select <b>Off / RAW / PCM</b> .	
<b>MTS</b>	Select the sound mode.	Press <b>◀</b> or <b>▶</b> to select <b>Stereo / SAP / Mono</b> . * Only available on ATV channel.	
<b>Accessibility</b>	Control the Voice Guide functions.	<b>Voice Guide</b>	Press <b>◀</b> or <b>▶</b> to set as <b>On</b> or <b>Off</b> . When the Voice Guide is <b>On</b> , the OSD will read out via voice once you operate the TV.
		<b>Volume</b>	Press <b>◀</b> or <b>▶</b> to select <b>Low, Middle</b> or <b>High</b> . * Only available after <b>Voice Guide</b> was set as <b>On</b> mode.
		<b>Speed</b>	Press <b>◀</b> or <b>▶</b> to select <b>Slow, Normal</b> or <b>Fast</b> . * Only available after <b>Voice Guide</b> was set as <b>On</b> mode.
		<b>Pitch</b>	Press <b>◀</b> or <b>▶</b> to select <b>Low, Middle</b> or <b>High</b> . * Only available after <b>Voice Guide</b> was set as <b>On</b> mode.
		<b>Video Description</b>	Press <b>◀</b> or <b>▶</b> to set as <b>On</b> or <b>Off</b> . When setting as <b>On</b> , the video description function is enabled and the video commentary text will appear.

# TV Settings

## Time Setting

1. Press **MENU** button to display the main menu.
2. Use ◀ or ▶ to highlight **Time** mode.
3. Use ▲ or ▼ to highlight the item you would like to reset, then press ◀ or ▶ to select the settings.
4. Press **MENU** to return to the previous menu or exit the setting.

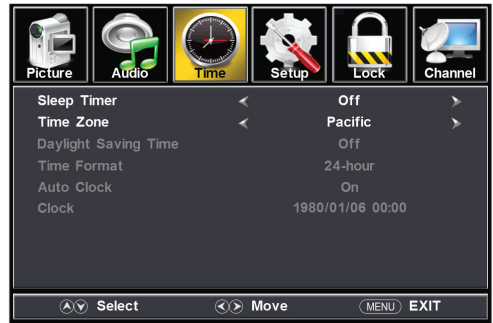

## Time Menu

<b>Sleep Timer</b>	Set the countdown time before TV automatically shutdown.	Press ◀ or ▶ to select <b>Off, 5min, 10min, 15min, 30min, 60min, 90min, 120min, 180min</b> or <b>240min</b> .
<b>Time Zone</b>	Set the time zone.	Press ◀ or ▶ to select <b>Pacific, Alaska, Hawaii, Samoa, Newfoundland, Atlantic, Eastern, Central</b> or <b>Mountain</b> .
<b>Daylight Saving Time</b>	Turn on/off daylight saving time.	Press ◀ or ▶ to set as <b>On</b> or <b>Off</b> . * Only adjustable on DTV channel
<b>Time Format</b>	Select the time display format.	Press ◀ or ▶ to set as <b>12-hour</b> or <b>24-hour</b> . * Only adjustable on DTV channel
<b>Auto Clock</b>	Set automatic time.	Press ◀ or ▶ to set as <b>On</b> or <b>Off</b> . * Only adjustable on DTV channel
<b>Clock</b>	Display the current date and time.	

# TV Settings

## Lock Setting

1. Press **MENU** button to display the main menu.
2. Use **◀** or **▶** to highlight **Lock** mode.
3. Use **▲** or **▼** to highlight “**Enter Password**” and input “**0000**” to enter the setup window.
4. Use **▲** or **▼** to highlight the item you would like to reset, then press **◀** or **▶** to select the settings.
5. Press **MENU** to return to the previous menu or exit the setting.

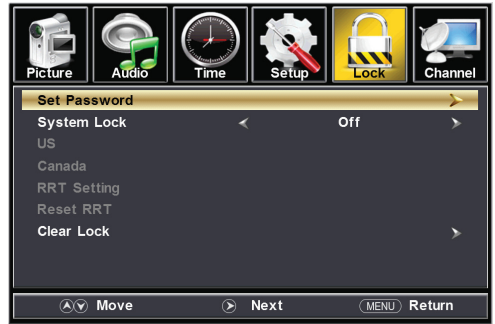

## Lock Menu

<b>Enter Password</b>	Input the password to access the Lock menu.	Use the Number Buttons (0-9) to enter the password. * Default password is 0000. * If you forgot the password, use 8888 to enter any locked menu.	
<b>Set Password</b>	Change the User Password.	<b>Set Password</b>	Use Number buttons (0-9) to enter a new password.
		<b>Confirm Password</b>	Repeat the password to confirm.
<b>System Lock</b>	Change the parental controls.	Press <b>◀</b> or <b>▶</b> to set as <b>On</b> or <b>Off</b> .	
<b>US Rating</b>	Set up parental locks based on US rating system . * Only available when <b>System Lock</b> is set as <b>On</b> mode.	<b>TV</b>	Press <b>▶</b> to enter the TV Ratings menu and use <b>▲</b> / <b>▼</b> / <b>◀</b> / <b>▶</b> to select your TV rating preference. (refer to the following tables of Age and Genre)
		<b>MPAA</b>	Press <b>◀</b> / <b>▶</b> buttons to select your movie rating preference based on US Rating System .
<b>Canada Rating</b>	Set up parental locks based on Canadian rating system . * Only available when <b>System Lock</b> was set as <b>On</b> mode.	<b>Canada English</b>	Press <b>◀</b> / <b>▶</b> buttons to select your ratings preference based on Canadian Rating System (English) .
		<b>Canada French</b>	Press <b>◀</b> / <b>▶</b> buttons to select your ratings preference based on Canadian Rating System (French) .

# TV Settings

## Lock Menu

<b>RRT Setting</b>	Set parental locks based on Canadian rating system. * Only available when the DTV code RRT traffic detected by the system	<b>Humor Level</b>	See Canadian Rating System table
		<b>Intelligence level</b>	See Canadian Rating System table
		<b>Erotic level 20CHARS</b>	See Canadian Rating System table
<b>Reset RRT</b>	Restore to default RRT settings.	Press <b>OK</b> or <b>▶</b> to enter the sub menu, then press <b>◀</b> or <b>▶</b> to select <b>Yes</b> or <b>No</b> .	
<b>Clear Lock</b>	Restore to default V-chip settings and clear the lock setting.	Press <b>OK</b> or <b>▶</b> to enter the sub menu, then press <b>◀</b> or <b>▶</b> to select <b>Yes</b> or <b>No</b> .	

# TV Settings

  
Picture

  
Audio

  
Time

  
Setup



  
Lock

  
Channel

**TV RATING**

	All	FV	V	S	L	D
TV-Y						
TV-Y7						
TV-G						
TV-PG						
TV-14						
TV-MA						

 Lock      Press OK to Lock or Unlock

 Move
 Select
 MENU Return

## US Rating System

<b>Off</b>	All Ages
<b>G</b>	General Audience
<b>PG</b>	Parental Guidance
<b>PG-13</b>	Parental Guidance below 13 years
<b>R</b>	Parental Guidance below 17 years
<b>NC-17</b>	Suitable for 17 years old or above
<b>X</b>	Adults Only

## Genre

<b>ALL</b>	All
<b>FV</b>	Fantasy Violence
<b>V</b>	Violence
<b>S</b>	Sex
<b>L</b>	Language
<b>D</b>	Dialogue

## Age

<b>TV-Y</b>	All Children
<b>TV-Y7</b>	Suitable for 7 years old or above
<b>TV-G</b>	General Audience
<b>TV-PG</b>	Parental Guidance
<b>TV-14</b>	Suitable for 14 years old or above
<b>TV-MA</b>	Suitable for 17 years old or above

## Canadian Rating System (English)

<b>E</b>	Exempt from the ratings (All ages)
<b>C</b>	Suitable for children age of 0–7 years
<b>C8+</b>	Suitable for children age over 8 years
<b>G</b>	General Audience
<b>PG</b>	Parental Guidance
<b>14+</b>	Suitable for viewers age over 14 years
<b>18+</b>	Suitable for adults over 18 years

## Canadian Rating System (French)

<b>E</b>	Exempt from the ratings (All ages)
<b>G</b>	General Audience
<b>8 ans+</b>	Suitable for children ages over 8 years
<b>13 ans+</b>	Suitable for children ages over 13 years
<b>16 ans+</b>	Suitable for viewers ages over 16 years
<b>18 ans+</b>	Suitable for adults over 18 years

# TV Settings

## Channel Setting

1. Press **MENU** button to display the main menu.
2. Use ◀ or ▶ to highlight **Channel** mode.
3. Use ▲ or ▼ to highlight the item you would like to reset, then press ◀ or ▶ to select the settings.
4. Press **OK** to confirm your selections or settings and enter the sub menus.
5. Press **MENU** to return to the previous menu or exit the setting.



### Channel Menu

<b>Air/Cable</b>	Set the reception type.	Press ◀ or ▶ to select <b>Air</b> or <b>Cable</b> . • Select <b>Air</b> when TV is connected to an indoor / outdoor antenna. • Select <b>Cable</b> if you subscribe to a pay television service WITHOUT a set top box.	
<b>Auto Scan</b>	Automatically scan for available channels. Press ▶ or <b>OK</b> to enter sub menu.	<b>Cable System</b>	Press ◀ or ▶ to select <b>Auto</b> , <b>STD</b> , <b>IRC</b> or <b>HRC</b> . (Only available when you select Cable as the reception type.)
		<b>Start to Scan</b>	Press ▶ or <b>OK</b> to start scanning available channels.
<b>Favorite</b>	Add or delete a channel in the favorite list.	Press ▲ or ▼ to select a channel, then press ▶ or <b>OK</b> to add or delete the channel in the favorite list.	
<b>Show/Hide</b>	Show or hide available channels already in memory.	Press ▲ or ▼ to select a channel, then press ▶ or <b>OK</b> to show or hide the channel.	
<b>Channel No.</b>	Select a channel number to be labeled.	Press ◀ or ▶ to select a channel.	
<b>DTV Signal</b>	Dynamically display the DTV signal status.		



# Change Settings

## USB Mode

1. After connecting a flash drive, press **SOURCE** button and select **Media**. Press **OK** or **▶** to enter.
2. Use **▲** or **▶** to select **Photo** or **Music**. Press **OK** or **▶** to enter.
3. Use **▲** or **▼** to navigate the files or folders on the USB drive.
4. Press **MENU** to return to the previous menu or press **EXIT** at any time to exit the setting.

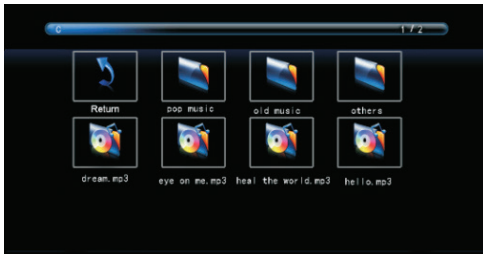
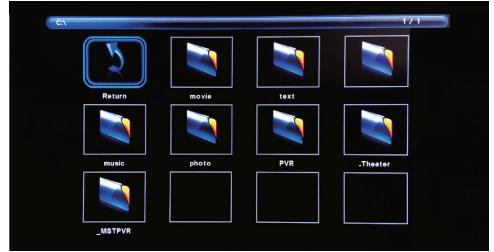

Playback of music is via this music player, which gives playback controls and information on the file.



When viewing photos, you can use this photo viewer tool to control slide show, play music and show file information.

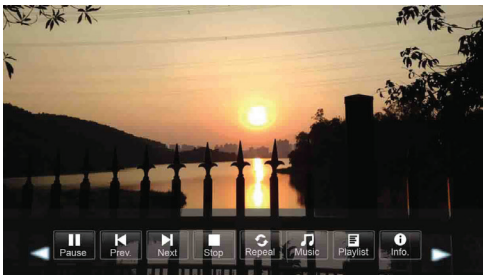

\* The music player plays MP3 audio format files.

\* The photo viewer displays .jpg photo format files.

# Troubleshooting

Problem	Solution/Issue
<b>TV does not operate</b>	<ul style="list-style-type: none"> <li>• Make sure the power cord is plugged in.</li> <li>• Try another AC outlet.</li> <li>• Power is off, check fuse or circuit breaker.</li> <li>• Unplug unit for an hour, then plug it back in.</li> </ul>
<b>Normal picture, but no sound</b>	<ul style="list-style-type: none"> <li>• Check the volume settings.</li> <li>• Sound muted? Press MUTE button.</li> <li>• Try another channel.</li> <li>• Check audio cable connections.</li> </ul>
<b>The remote control does not work</b>	<ul style="list-style-type: none"> <li>• Make sure the remote control is in range with no obstructions.</li> <li>• Check the batteries.</li> <li>• Correct operating mode set: TV, VCR etc.</li> </ul>
<b>Poor sound or no sound</b>	<ul style="list-style-type: none"> <li>• Station or Cable TV experiencing problems, tune to another station.</li> <li>• Check sound adjustments (Volume or Mute).</li> <li>• Check for sources of possible interference.</li> </ul>
<b>Poor picture or no picture</b>	<ul style="list-style-type: none"> <li>• Station or Cable TV experiencing problems, tune to another station.</li> <li>• Make sure channels are set into memory.</li> <li>• Check antenna or Cable TV connections, adjust antenna.</li> <li>• Check the possible interference sources.</li> <li>• Check picture control adjustments.</li> </ul>
<b>Poor TV reception</b>	<ul style="list-style-type: none"> <li>• Ensure the antenna amplifier is turned on for Antenna TV.</li> <li>• Adjust the antenna position to a stronger signal receiving angle.</li> <li>• Check if the Antenna connection is tight to the TV.</li> <li>• Check if there is power supplied to the Antenna distribution box.</li> <li>• Confirm your incoming cable is connected to the correct cable / antenna wall connection inside the RV.</li> <li>• Ensure the internal RV coax jump cable is connected to the correct port.</li> </ul>
<b>Poor Cable / Satellite TV Reception</b>	<ul style="list-style-type: none"> <li>• Ensure antenna amp is turned off for cable signal.</li> <li>• Check if incoming Cable is connected correctly to RV.</li> <li>• Ensure cable splitter box has power.</li> <li>• Check if the incoming cable is connected to the correct cable / Satellite wall connection inside your RV.</li> <li>• Ensure the internal RV coax jump cable is connected to the correct port.</li> <li>• Ensure Dish has no obstruction.</li> </ul>
<b>TV shuts off</b>	<ul style="list-style-type: none"> <li>• Sleep Timer is set.</li> <li>• Power interrupted.</li> </ul>
<b>Black and white image from the connected AV device</b>	<ul style="list-style-type: none"> <li>• Check video connections on both the TV and connected AV device. Ensure the colors match between the connectors and sockets: green (Y), blue (Pb/Cb) and red (Pr/Cr) for component connection, and yellow (VIDEO) for composite connection.</li> <li>• Ensure all video cables are connected firmly.</li> </ul>

# Specifications

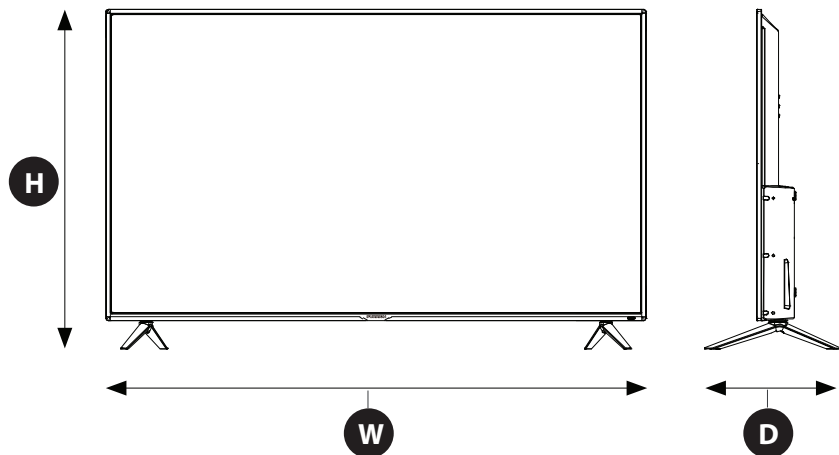

## MODEL, DIMENSION & RESOLUTION

Model	Dimension without Stand (W*H*D)	Dimension with Stand (W*H*D)	Max Resolution
FDUS50F1A	44 <sup>3</sup> / <sub>16</sub> " X 25 <sup>1</sup> / <sub>2</sub> " X 3 <sup>5</sup> / <sub>16</sub> " (1122 x 647 x 83 mm)	44 <sup>3</sup> / <sub>16</sub> " X 27 <sup>13</sup> / <sub>16</sub> " X 11 <sup>3</sup> / <sub>4</sub> " (1122 x 706 x 285 mm)	3840X2160 @ 60Hz UHD

## INPUT & OUTPUT CONNECTIONS

Model	AUDIO OUT	OPTICAL OUT	VIDEO IN	L-AUDIO IN-R	Y <b>P</b> <sub>b</sub> P <sub>r</sub> VIDEO IN	HDMI IN	RF IN	USB
FDUS50F1A	1	1	1	1 x White (L) 1 x Red (R)	1 x Green 1 x Blue 1 x Red	3	1	1

# Specifications

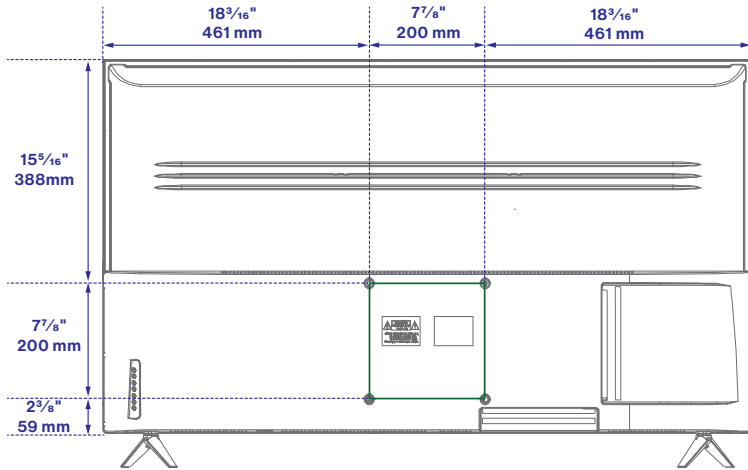

## VESA MOUNTING PATTERN

Model	Width mm	Height mm	Screw Size	Quantity
FDUS50F1A	200	200	M6X10	4

**FURRION**

**Furrion Innovation Center & Institute of Technology**

- 52567 Independence Ct., Elkhart, IN 46514, USA • Toll free: 1-800-789-3341
- Email: [support@furrion.com](mailto:support@furrion.com)

©2007-2020 Furrion Ltd. Furrion® and the Furrion logo are trademarks licensed for use by Furrion Ltd. and registered in the U.S. and other countries.

**FURRION.COM**